

Article number: 20021395

Description: E+G
Indexing plunger GN 607.3-8-12-ST

Measures

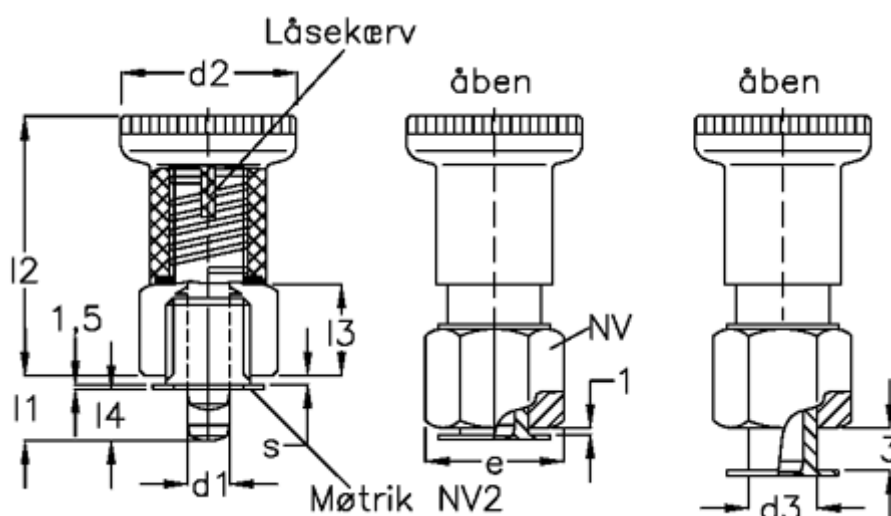

AL = 500	l4	= 7.5
d1 = 8	NV 1	= 19
d2 = 31	NV 2	= 16
d3 = 12	s	= 1-5
e = 22.0	Spring pressure N bottom	= 28
l1 = 12.0	Spring pressure N top	= 15.5
l2 = 40		
l3 = 12		